

Zigbee Microwave Induction Switch

- Ceiling mounting microwave motion detectors with HF system 10.525GHz, built-in daylight sensor.
- Output Zigbee 3.0 signal, intelligent linkage to turn on/off other Tuya Zigbee or WiFi series lighting controllers.
- Output 1 channel 0/1-10V signal, connect with 0/1-10V dimmable driver.
- High voltage AC input, High voltage AC relay output with zero-cross detection.
- Tuya APP cloud control, support motion detection sensitivity, light sensitivity, time delay on/off, timer operation and intelligent linkage to other devices.
- Work as RF remote, output RF 2.4G signal, remote control other RF LED controller or RF dimmable LED driver optional.

CE RoHS  RED

Technical Parameters

Working voltage	100-240VAC
Output signal	Zigbee 3.0, 0/1-10V (Max.30mA), RF 2.4GHz
Output current	Max 4A (AC)
HF system	10.525GHz
Power consumption	<1.3W (Operation)
Detection zone	Max.(\varnothing xH) 20 x 10m
Detection Sensitivity(\varnothing xH)	Low(6x3m) / Middle(15x7m) / High(20x10m)(ceiling installation)
Light Sensitivity	From Day to Night, five levels
Hold time	5 Second - 1 Hour
Mounting height	10m Max.
Motion detection	0.5-3m/s
Detection angle	360°(ceiling installation)
Operation temperature	Ta: -20°C ~ +50°C
IP rating	IP20
Warranty	5 years

Mechanical Structures and Installations

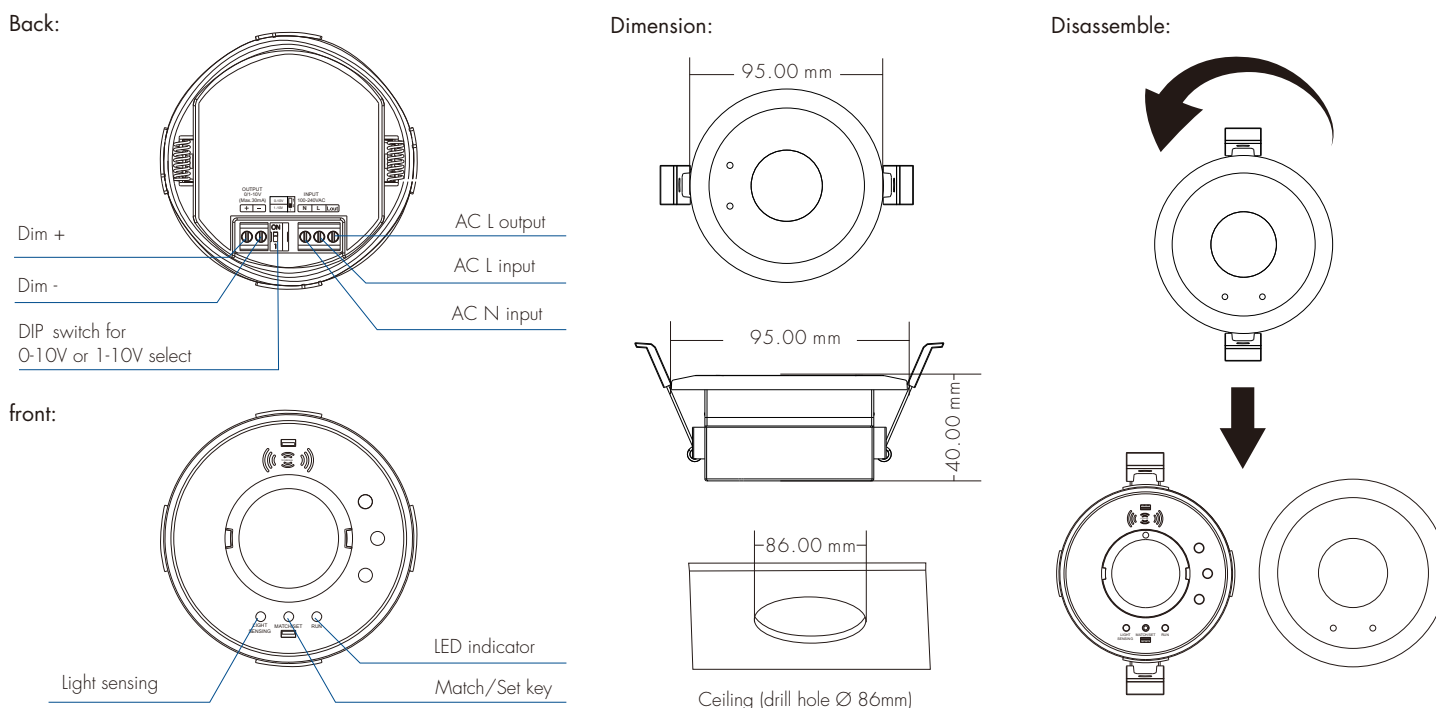

System Wiring

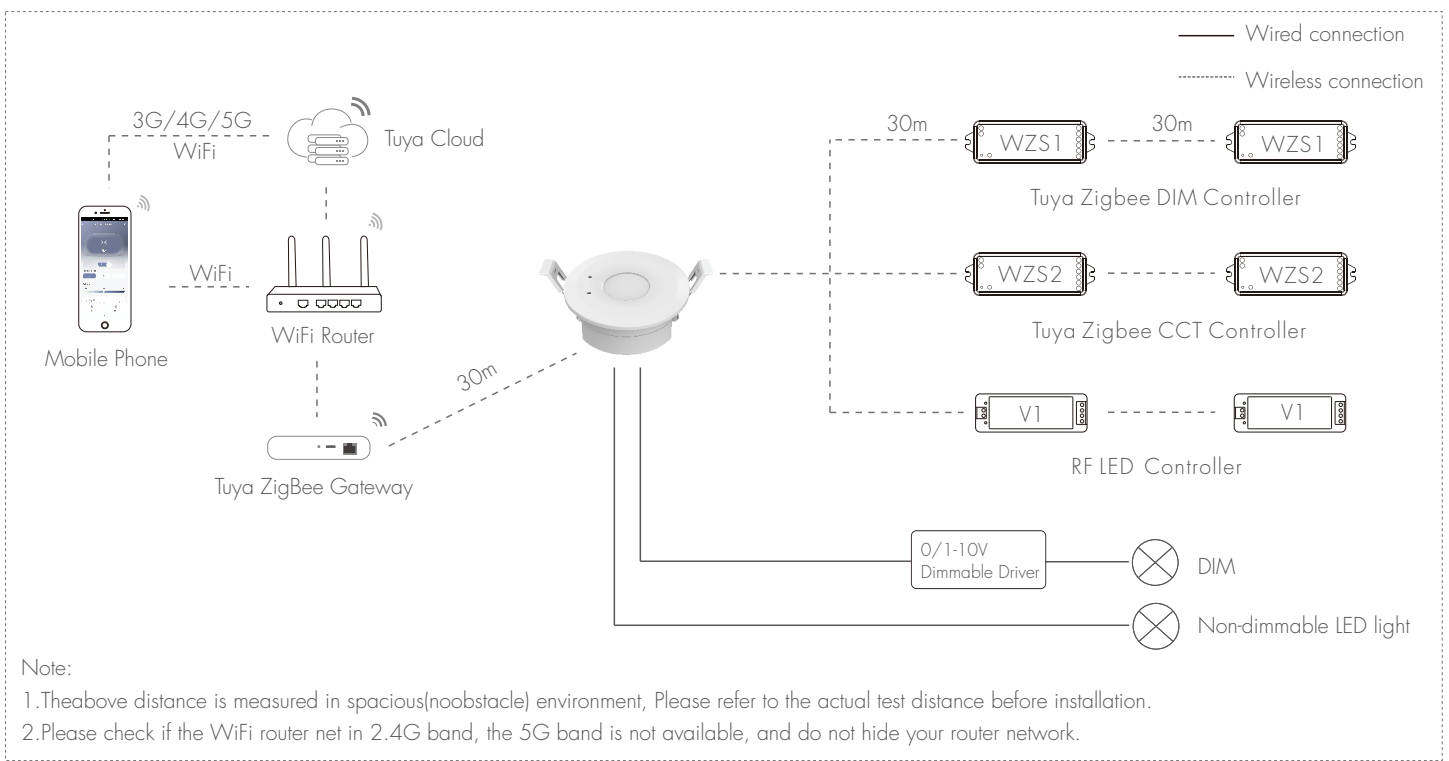

Wiring Diagram

- Connect with 0/1-10V dimming driver

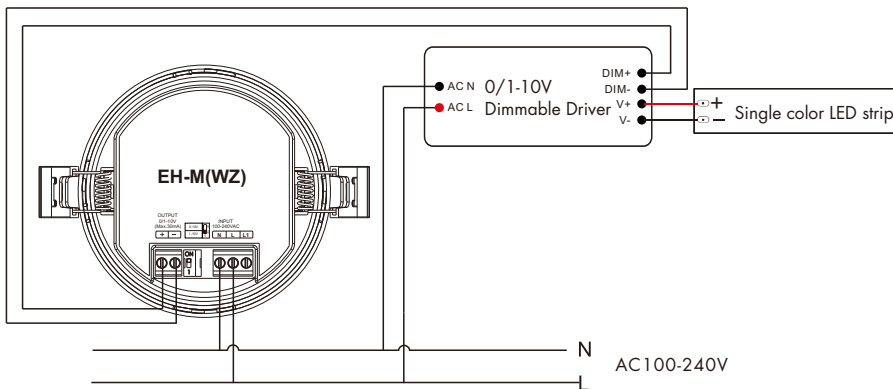

- Connect with non-dimmable LED light (use AC OUT)

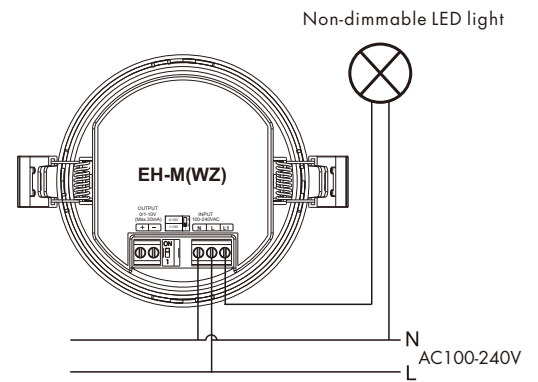

Microwave Induction Switch Work as RF Remote

The microwave induction switch can be matched with one or multiple RF LED controller or RF dimmable LED driver, including single color, dual color, RGB, RGBW, RGB+CCT or switch light type, turn on or turn off light by motion detection.

End user can choose the suitable match/delete ways. Two options are offered for selection:

Use the controller's Match key

Match:

Short press the match key of the controller, immediately press the match key of the microwave induction switch.

Delete:

Press and hold the match key of the controller for 5s to delete all match, The light blinks 5 times means all matched remotes were deleted.

Use Power Restart

Match:

Switch off the power of the controller, then switch on power, repeat again. Immediately short press the match key of the microwave induction switch 3 times. The light blinks 3 times means match is successful.

Delete:

Switch off the power of the controller, then switch on power, repeat again. Immediately short press the match key of the microwave induction switch 5 times. The light blinks 5 times means all matched remotes were deleted.

Note:

The Match key of the microwave induction switch also has a short press manual on/off function, i.e. on/off AC relay output, on/off 0/1-10V signal output, and send RF on/off command.

APP Network Connection

- Step 1: Please download Tuya Smart/Smart Life APP according to your region.
- Step 2: Connect to the Zigbee gateway via APP (see gateway connection manual for specific steps).
Click "Add Sub-device" in the gateway interface to search for the current device.
- Step 3: Network pairing, long press Match/Set key for 5s, or push twice Match/Set key fastly, clear previous network connection, enter Smart config mode, the LED indicator will fast flash. (Smart config mode keep 30s, after 30s smart config mode will exit automatically).
- Step 4: The LED indicator stops blinking and the "microwave sensor" device has been successfully added to the Tuya Smart/Smart Life APP.
- Clear network pairing: Long press Match/Set key for 10s, the LED indicator fast flash means network pairing is cleared.

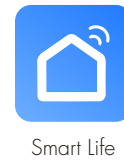

APP Interface

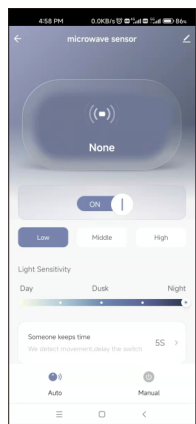

Auto-operation interface

Automatic detection mode can be switched on or off,
Three motion detection sensitivity:
Low (6x10m), Medium (15x10m), High (20x10m).

Five light sensitivity: From Day to Night
(400lux, 250lux, 50lux, 30lux, 10lux).

Someone keeps time setting: 5S-1H.

Intelligent linkage setting: you can add conditions to trigger the conditions after execute the linkage control of the microwave induction switch and other Tuya Zigbee or WiFi devices.

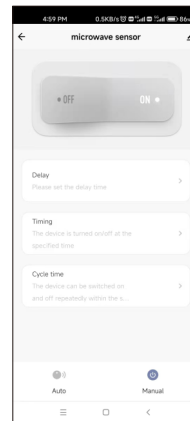

Manual operation interface

Manual on/off microwave induction switch.

Delay setting: set delay off in 5S-12H.

Timing setting: set to turn on and off at specified times of the week.

Cycle time setting:
within 24 hours per day,
set to turn on and off repeatedly.

Intelligent linkage setting (For example: EH-M(WZ) + WZS1 + WZS2)

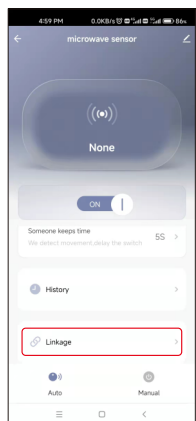

Select "Linkage"

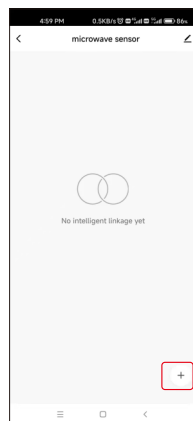

Add "One Click Execution"

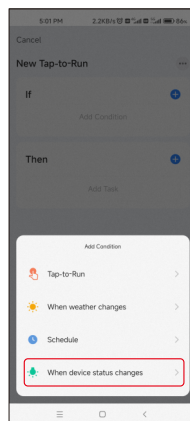

Add "Conditions"

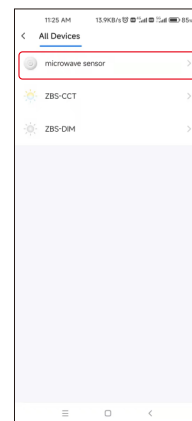

Select "Devices"

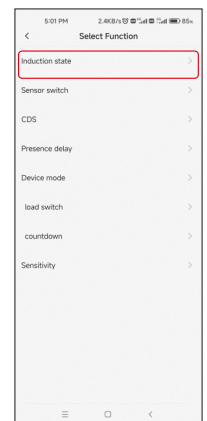

Select induction state "Sense someone"

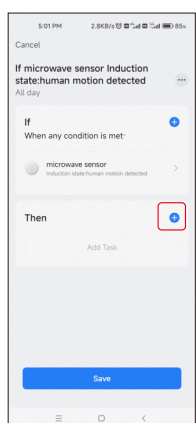

Select "Add Task"

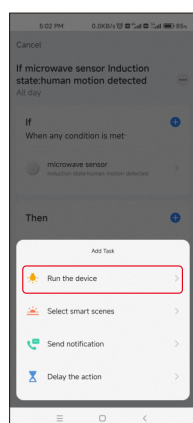

Select device ZBS-DIM and ZBS-CCT

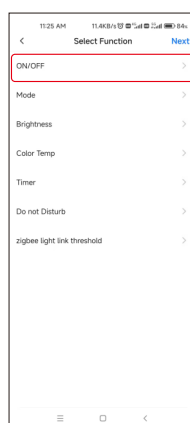

ZBS-DIM Select "ON/OFF" function



ZBS-CCT Select "ON/OFF" function

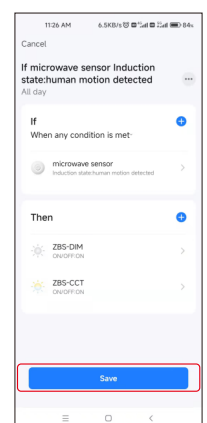

When setup is complete, select "Save"

Sensor Detection Range

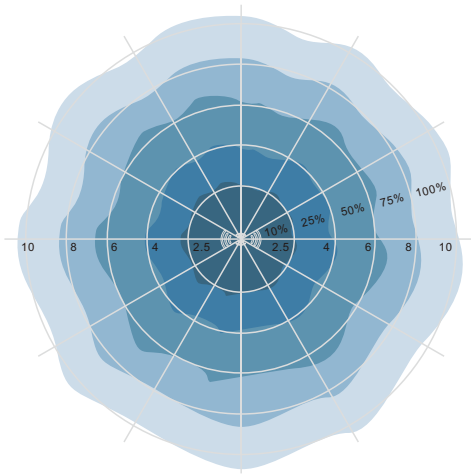

Ceiling mounting(Unit:m)
Suggested installation height: 2.5-10m

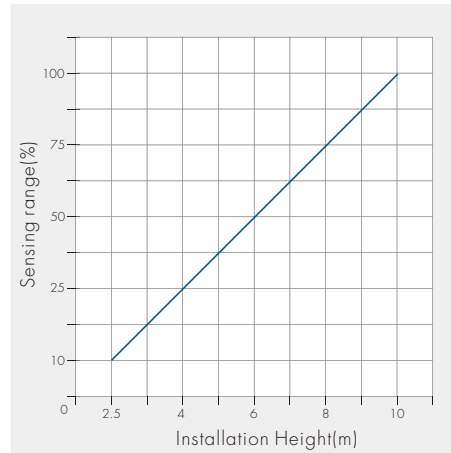

Typical Application

After microwave induction switch is set successfully via Tuya/Smart Life APP,
Turns on the light upon detection of motion, and turns off after a pre-selected hold time when there is no movement.

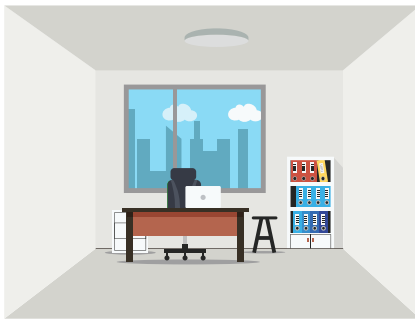

1. With sufficient ambient light,
the sensor does not turn on the light.

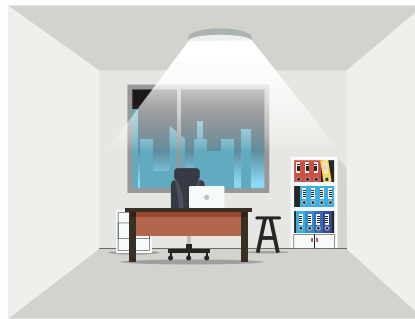

2. With insufficient ambient light,
the sensor turns on the light when motion
is detected.

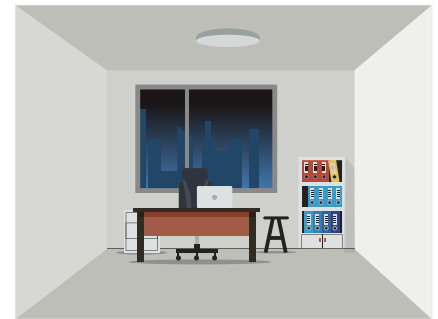

3. After hold time, the light turns off if no
motion detected.

Application Notice

1. The sensor is designed for indoor use only.
The raining or wind blowing may trigger the microwave sensor even if without human motion when outdoor use.
2. The sensor should be installed by a professional electrician. please turn off the power before installing, wiring and changing setting of the knob.
3. The distance between any two sensors should be at least 3m to avoid interference each other.
4. When the microwave sensor is installed in space with large reflector, for example a warehouse with metal roof,
the microwave signal will be reflected and cause the lights permanent illuminated even if without motion signal.
Please reduce the detection area to solve the problems.
5. Make sure the sensor not close to or be blocked by high density materials, such as metal, glass, concrete walls etc.
The materials will reduce or block microwave signal and cause false trigger.
6. The light sensitivity threshold is in a sunny environment, no shadow and ambient light diffuse reflection.
Ambient lux level could be different in different environment, weather, climate, time-of-delay and season.
7. Make sure there are no fans, DC motor, or other vibrating objects in installation area. The movement will trigger sensor as well.