

LED CT Intelligent Driver (CV)

- Leading edge (Triac), Trailing edge (ELV) phase-cut and Push DIM/CCT.
- With soft-on and fade in function, visual more comfortable.
- 2 independently SELV constant voltage output channels.
- Constant power design, adjust brightness and color temperature synchronously.
- Dimming range: 0~100%, LED start at 0.1% possible.
- 0-100% flicker-free, High frequency exemption level.
- High Efficient driver: efficiency 88%, PF>0.98, THD<6%
- Innovative thermal management technology, intelligent power life protection.
- Over load / Over temp. / Short circuit / Over voltage protection, recover automatically.
- Suitable for internal lights application for I /II/III.
- Up to 50000-hour life time.
- 5 years warranty (Rubycon capacitor).

Flicker-free
IEEE 1789
High frequency exemption level.

Dimmable:
Max: 0.1-100%

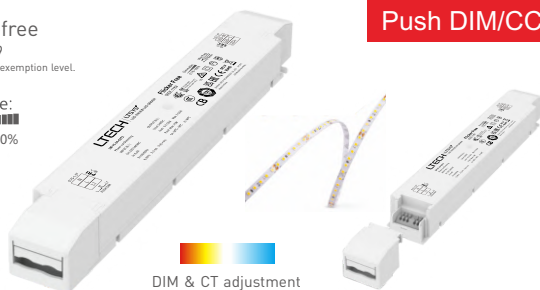

DIM & CT adjustment



(The certification icon represents undergoing certification applications only, and final certification qualification subject to actual product.)



Specification

Model	LM-75-24-G2T2	LM-75-12-G2T2	
OUTPUT	Output voltage	24Vdc	12Vdc
	Output voltage range	24Vdc ± 0.5Vdc	12Vdc ± 0.5Vdc
	Output current	Max. 3.125A	Max. 6.25A
	Output power	Max. 75W	
	Output power range	0~75W	
	Strobe level	High frequency exemption level.	
	Dimming range	0~100%, dimming depth: Max. 0.1%	
	Overload power limitation	≥102%	
	Ripple & Noise	≤150mV	
PWM frequency	3600Hz		
INPUT	Dimming interface	Leading edge (Triac), Trailing edge (ELV) phase-cut and Push DIM/CCT.	
	Input voltage	220-240Vac	
	Frequency	50/60Hz	
	Input current	230Vac≤0.4A	
	Power factor	PF>0.98/230Vac , at full load	
	THD	230Vac@THD<6%, at full load	
	Efficiency (typ.)	88%	87%
	Inrush current(typ.)	Cold start 30A at 230Vac	
	Control surge capability	L-N: 2kV	
Leakage current	Max. 0.5mA		
ENVIRONMENT	Working temperature	ta: -20 ~ 50°C tc: 90°C	
	Working humidity	20 ~ 95%RH, non-condensing	
	Storage temp., humidity	-40°C ~ 80°C, 10-95%RH	
	Temp. coefficient	±0.03%/°C(0-50°C)	
	Vibration	10-500Hz, 2G 12min./1cycle, period for 72min. each along X, Y, Z axes.	
PROTECTION	Over-heat protection	Intelligently adjusting or turning off the output current if the PCB temperature ≥110°C, auto recovers.	
	Over load protection	Shut down the output when current load ≥102%, auto recovers.	
	Short circuit protection	Shut down automatically if short circuit occurs, auto recovers.	
	Over voltage protection	Shut down the output when non-load voltage ≥26V, re-power on to recover after fault condition is removed.	Shut down the output when non-load voltage ≥13V, re-power on to recover after fault condition is removed.
SAFETY & EMC	Withstand voltage	I/P-O/P: 3750Vac	
	Isolation resistance	I/P-O/P: 100MΩ/500VDC/25°C/70%RH	
	Safety standards	IEC/EN61347-1, IEC/EN61347-2-13	
	EMC emission	EN55015, EN61000-3-2 Class C, IEC61000-3-3	
	EMC immunity	EN61000-4-2,3,4,5,6,8,11, EN61547	
	Strobe test standard	IEEE 1789	
OTHERS	Dimension	293×43×30mm(L×W×H)	
	Packing	296×44×33mm(L×W×H)	
	Weight(G.W.)	350g±10g	

* The driver is suitable for connecting resistor current-limiting LED fixture (e.g. LED strip). The inrush current will be dozens of times increased if connecting built-in constant current IC current-limiting LED fixtures, the driver will activate the overloaded protection (hiccup flickering). When you order, please remark controlling the constant current LED fixture (e.g. MR16 lamp, underground light, LED wall washer, constant current LED strip, etc.), then we can prepare the special programs.

Dimensions

Unit: mm

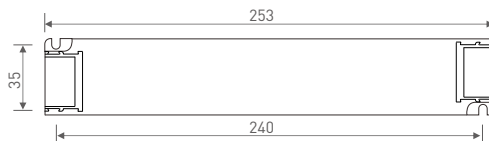
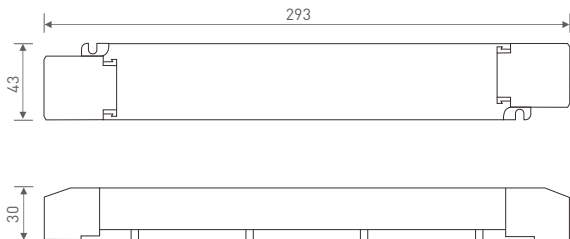

Wiring Diagram

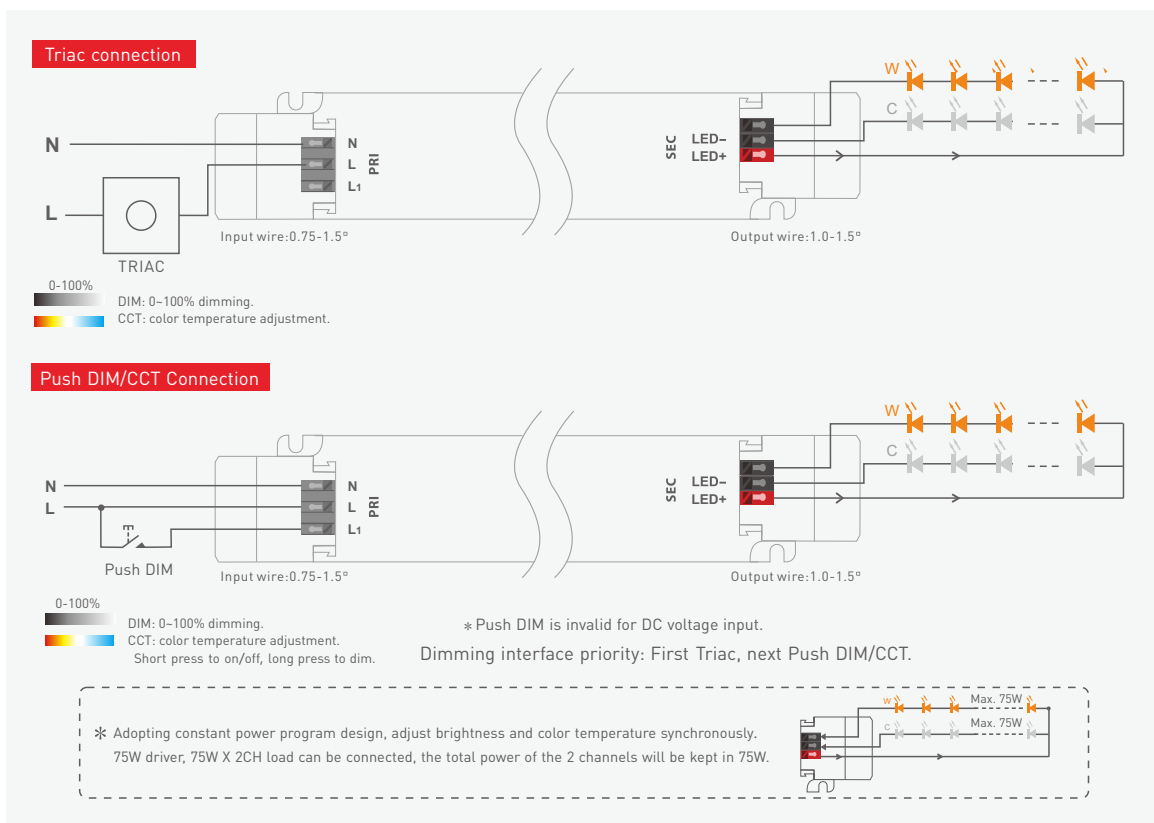

Push Dimming



Reset switch

- On/off control: Short press.
 - Stepless dimming: Long press.
 - With every other long press, the brightness goes to the opposite direction.
 - Dimming memory: The lights will return to its previous brightness value when short press on PUSH DIM button.
- Power on again after power cut, the output brightness is subjected to the input voltage of drivers.

Protective Housing Application Diagram

Tension plate

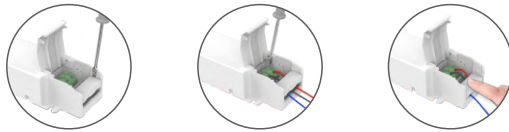

1. Pry up the protecting housing in the side plate position with a tool.
2. Connect to electrical wires with a screwdriver as wiring diagram shows.
3. Press down the tension plate to fix the the electrical wires, then close the protective housing.

Remove the protective housing



- Pull the housing left and right from the bottom to remove it.

Installation Precautions

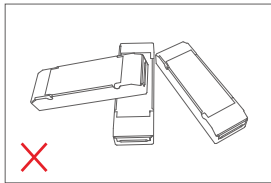

Please do not stack the products. The distance between two products should be $\geq 15\text{cm}$ so as not to affect heat dissipation and the lifespan of the products.

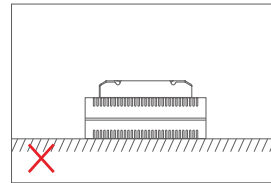
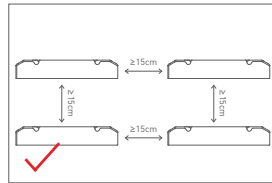

Please not place the products on LED drivers. The distance between the product and the drivers should be $\geq 15\text{cm}$ so as not to affect heat dissipation and shorten the lifespan of the products.

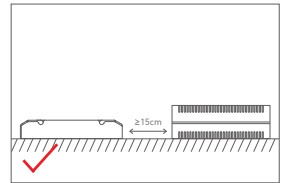

Relationship diagrams

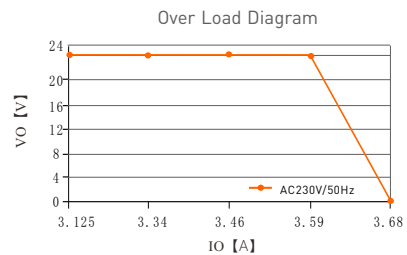
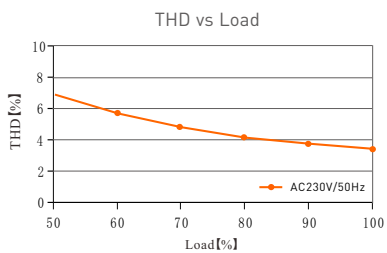
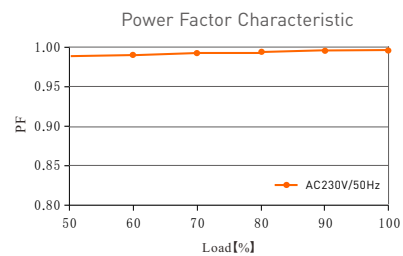
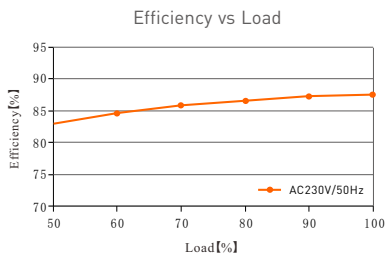

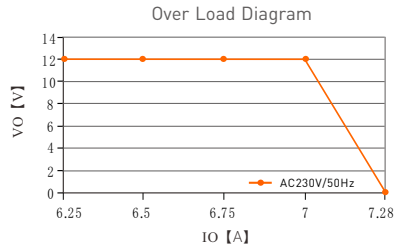
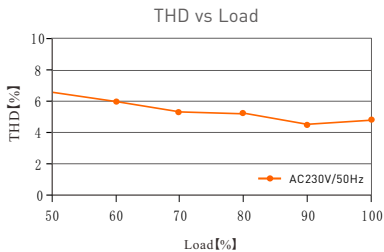
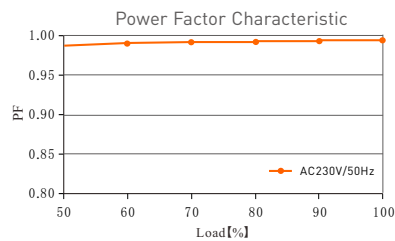
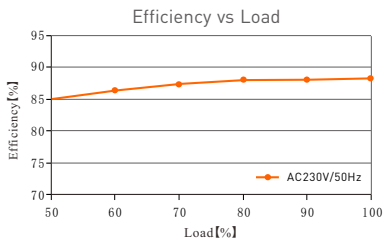

LM-75-12-G2T2

Flicker Test Form

IEEE 1789

Limit of Modulation in low risk area	
Waveform frequency of Optical output	limit (%)
$f \leq 8\text{Hz}$	0.2
$8\text{Hz} < f \leq 90\text{Hz}$	$0.025 \times f$
$90\text{Hz} < f \leq 1250\text{Hz}$	$0.08 \times f$
$f > 1250\text{Hz}$	Exemption assessment
Limit of Modulation in no effect area	
Waveform frequency of Optical output	limit (%)
$f \leq 10\text{Hz}$	0.1
$10\text{Hz} < f \leq 90\text{Hz}$	$0.01 \times f$
$90\text{Hz} < f \leq 3125\text{Hz}$	$(0.08/2.5) \times f$
$f > 3125\text{Hz}$	Exemption assessment (High frequency exemption)

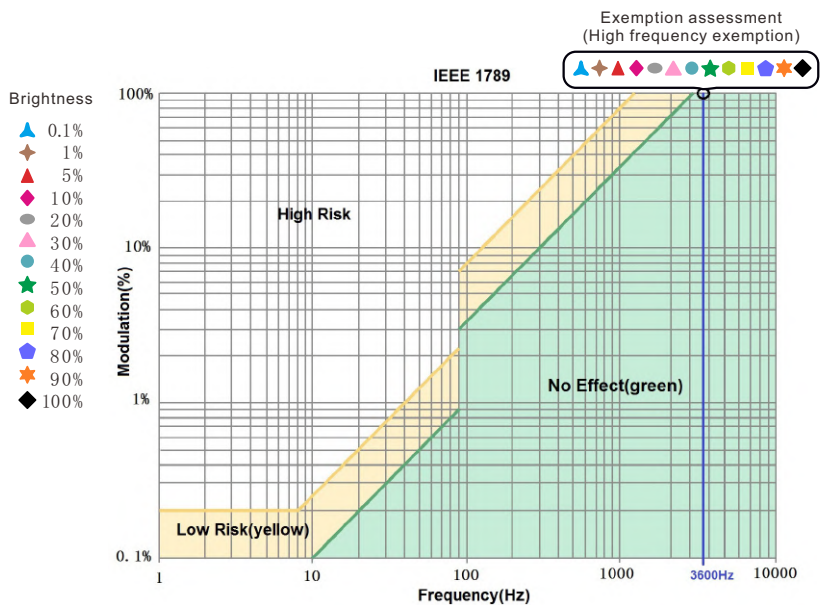

Packaging Specifications

Model	LM-75-24-G2T2
Carton Dimensions	315×230×215mm(L×W×H)
Quantity	10 PCS/Layer; 3 Layers/Carton; 30 PCS/Carton
Weight	0.35 kg/PC; 11.3 kg/Carton

Packaging Image



Inner Packaging Box



Carton Packaging

Transportation and Storage

1. Transportation

Products can be shipped via vehicles, boats and planes.

During transportation, products should be protected from rain and sun. Please avoid severe shock and vibration during the loading and unloading process.

2. Storage

The storage conditions should comply with the Class I Environmental Standards. The products that have been stored for more than six months are recommended to be re-inspected and can be used only after they have been qualified.

Attentions

- This product must be installed and adjusted by a qualified professional.
- This product is non-waterproof (special models excepted). Please avoid the sun and rain. When installed outdoors, please ensure it is mounted in a water proof enclosure.
- Good heat dissipation will extend the life the product. Please install the product in a environment with good ventilation.
- When you install this product, please avoid being near a large area of metal objects or stacking them to prevent signal interference.
- Please keep the product away from a intense magnetic field, a high pressure area or a place where lightning is easy to occur.
- Please check whether the working voltage used complies with the parameter requirements of the product.
- Before you power on the product, please make sure all the wiring is correct in case of incorrect connection that may cause a short circuit and damage the components, or trigger a accident.

If a fault occurs, please do not attempt to fix the product by yourself. If you have any question, please contact the supplier.

* This manual is subject to changes without further notice. Product functions depend on the goods. Please feel free to contact our official distributors if you have any question.

Warranty Agreement

- Warranty periods from the date of delivery: 2 years.
- Free repair or replacement services for quality problems are provided within warranty periods.

Warranty exclusions below:

- Beyond warranty periods.
- Any artificial damage caused by high voltage, overload, or improper operations.
- Products with severe physical damage.
- Damage caused by natural disasters and force majeure.
- Warranty labels and barcodes have been damaged.
- No any contract signed by LTECH.

1. Repair or replacement provided is the only remedy for customers. LTECH is not liable for any incidental or consequential damage unless it is within the law.
2. LTECH has the right to amend or adjust the terms of this warranty, and release in written form shall prevail.

Update Log

Version	Updated Time	Update Content	Updated by
A3	2022.03.17	Updated the silkscreen on the product.	Xushujun