

WiFi & RF AC Triac Dimmer Kit

Model No.: S1-B(WT)+R11

Features

- WiFi + RF + Push AC phase-cut dimmer, 1 channel output.
- To dim and switch single color dimmable LED lamps, traditional incandescent and halogen lights.
- Tuya smart APP cloud control, support on/off, brightness adjust, delay turn on/off light, timer run, scene function.
- Leading edge dimming or trailing edge dimming set by dip switch.
- Min brightness can be set by key.
- Light on/off fade time 3s selectable.
- Connect with external push switch to achieve on/off and dimming function.
- Easy to be inserted into standard 86*86mm wall box.

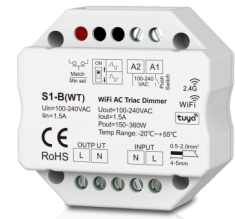

CE RoHS LVD

Technical Parameters

Triac Dimmer's Input and Output		LED Remote's Input and Output		Safety and EMC	
Input voltage	AC100-240V	Output signal	RF(2.4GHz)	EMC standard (EMC)	ETSI EN 301 489-1 V2.2.3 ETSI EN 301 489-17 V3.2.4
Output voltage	AC100-240V	Working voltage	3VDC(CR2032)	Safety standard(LVD)	EN 62368-1:2020+A11:2020
Output current	Max 1.5A	Working current	<5mA	Radio Equipment(RED)	ETSI EN 300 328 V2.2.2
Output power	150-360W	Standby current	<10μA	Certification	CE,EMC,IVD,RED
Dimming signal	WiFi + RF + Push Dim	Standby time	<1 years	Environment	
Dimming level	256 levels	Remote distance	30m(Barrier-free space)	Operation temperature	Ta: -20 °C ~ +55 °C
Dimming range	0-100%				

Compatible Load Types

Load type	Maximum load	Remarks
Dimmable LED lamps	200W @ 220V 100W @ 110V	Due to variety of LED lamp designs, maximum number of LED lamps is further dependent on power factor result when connected to dimmer.
Triac dimmable LED drivers	200W @ 220V 100W @ 110V	Maximum permitted number of drivers is 200W divided by driver nameplate power rating, and make sure the surge current is no more than 2 times 65A.
Incandescent lighting, HV halogen lamps	400W @ 220V 200W @ 110V	

Recommended number of load connection

Load type	Output power per load	Quantity
Dimmable downlight	5.5W @ 220V~240V	20
Triac dimmable LED driver	12W @ 200V~240V	15
Triac dimmable LED driver	36W @ 200V~240V	4
Triac dimmable LED driver	75W @ 200V~240V	2

Because different manufacturers triac dimmable LED driver nameplate power rating is different, you can refer to the formula to calculate the max. number of LED driver. Formula: $D_{max} = 200W/RP$, at the same time need to meet the sum of the surge current (I_{surge}) does not exceed 130A. For example: triac dimmable LED driver nameplate power rating(RP) = 15.4W, surge current = 10A/230VAC, Then $D_{max} = 200/15.4 = 13$ (pcs), $I_{surge} = 13 * 10 = 130A$, the max. number of triac dimmable LED driver is 13.

Mechanical Structures and Installations

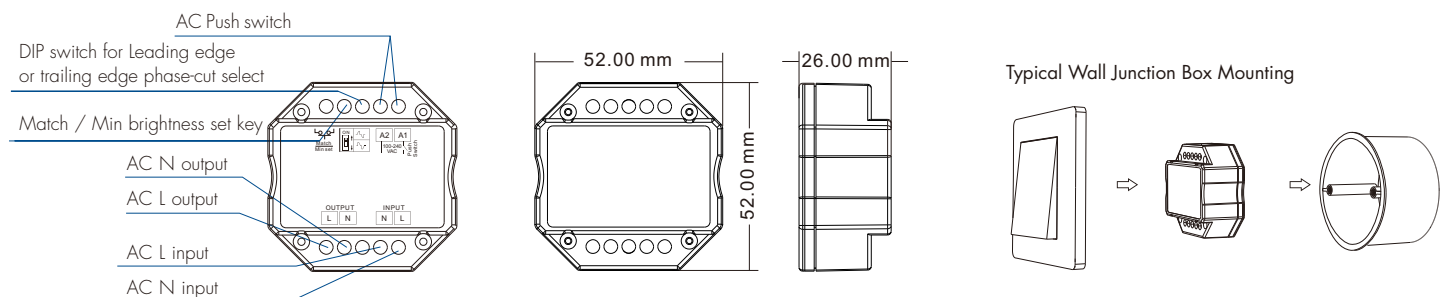

Remote function

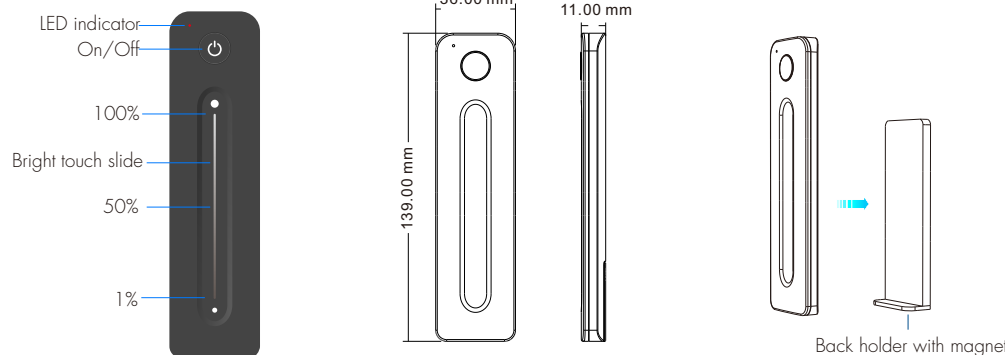

System wiring

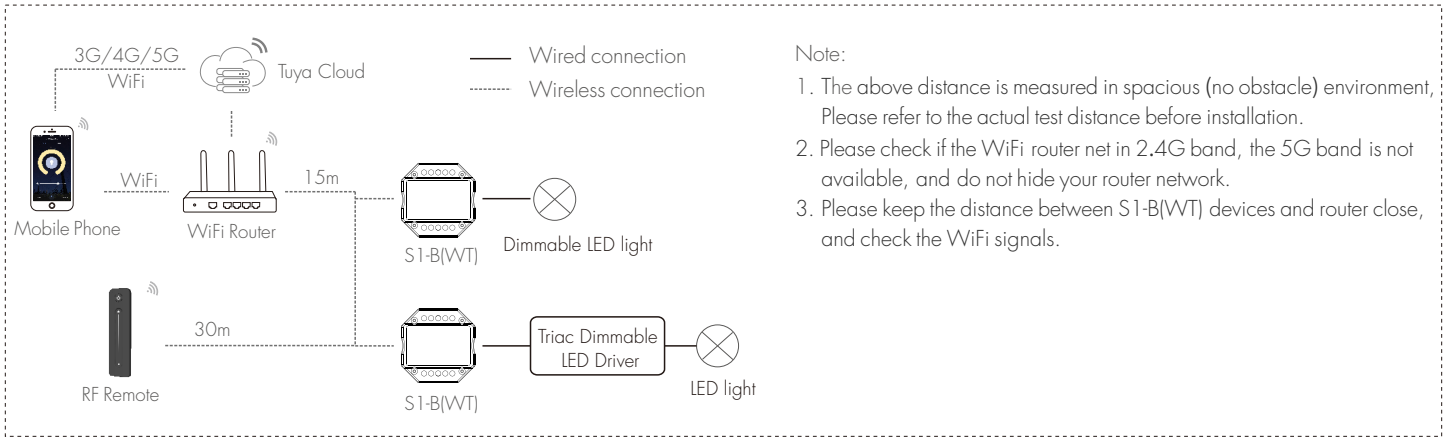

Wiring diagram

⚠ Caution: Please carefully ensure all wire connections and polarities are correct and secure before applying power, otherwise this controller will be damaged.

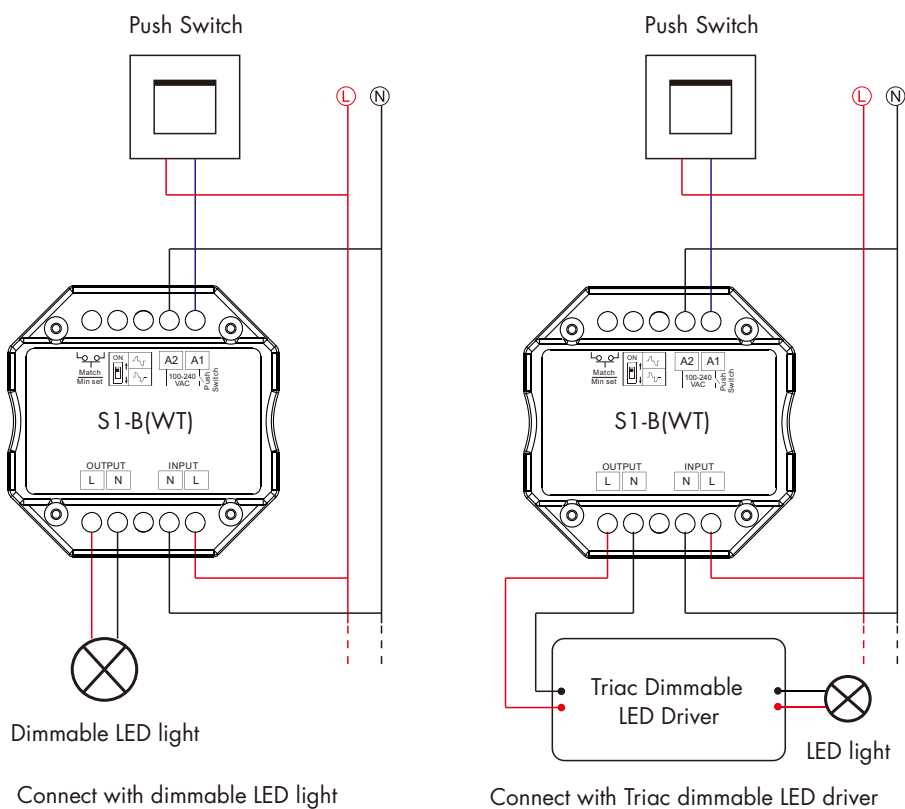

Leading edge or trailing edge dimming setting

Select leading edge(forward-phase) dimmer or trailing edge(reverse-phase) dimmer according to dimmable LED light or driver.

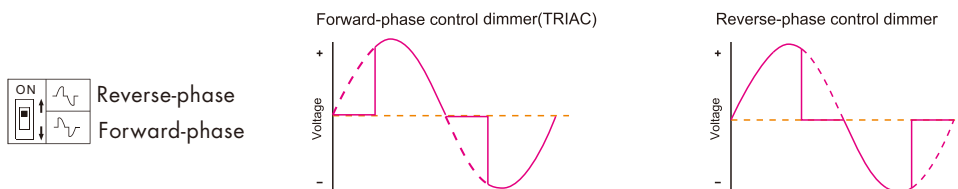

Caution: before power on, you must confirm the selection of dip switch.

Min brightness setting

Long press Min set key for 10s, the light blink 2 times, ready for min brightness set, then short press Min set key 1-6 times, to get 6 min brightness: 5%, 10%, 15%, 20%, 25% or 30%, the light will output the current min brightness immediately, wait 8s, quit min brightness set automatically, the light will return output 100% brightness.

Light on/off fade time

Switch off the power, then switch on power, repeat again. Immediately short press match key 3 times, the light on/off time will change between 3s and 0.5s.

Tuya Smart APP network connection and operation

Press and hold Match/Set key for 2s, or push twice Match/Set key fastly,
Clear previous network connection, enter Smart config mode, the blue LED indicator flash fastly.

Press and hold Match/Set key for 5s:
Clear previous network connection, enter AP config mode, the blue LED indicator flash slowly.
If smart config failed, please try AP config.

If Tuya smart APP network connection succeed,
the blue LED indicator will stop flash,
and in Tuya APP, you can find Triac dimmer device.

Tuya smart APP interface operation:
Touch brightness slide to adjust brightness.

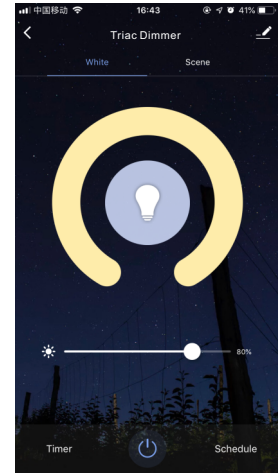

Match RF remote control

End user can choose the suitable match/delete ways. Two options are offered for selection:

Use the S1-B(WT)'S controller's Match key

Match:
Short press match key of S1-B(WT),
immediately press on/off key on the remote.

Delete:
Press and hold match key for S1-B(WT) for 5s to delete all match,
The light blinks 5 times means all matched remotes were deleted.

Use Power Restart

Match:
Switch off the power of S1-B(WT), then switch on power, repeat again,
Immediately short press on/off key 3 times on the remote.
The light blinks 3 times means match is successful.

Delete:
Switch off the power of S1-B(WT), then switch on power, repeat again,
Immediately short press on/off key 5 times on the remote.
The light blinks 5 times means all matched remotes were deleted.

AC Push Dim Function

- Short press:
Turn on or off light.
- Long press (1-6s):
Press and hold to step-less dimming,
With every other long key press, the light level goes to the opposite direction.
- Dimming memory:
Light returns to the previous dimming level when switched off and on again, even at power failure.